

**KAF - 1600**

**1536 (H) x 1024 (V) Pixel**

**Full-Frame CCD Image Sensor**

**Performance Specification**

**Eastman Kodak Company**

**Microelectronics Technology Division**

**Rochester, New York 14650-2010**

**Revision 3**

**August 12, 1998**



## TABLE OF CONTENTS

1.1 Features .....	3
1.2 Description .....	3
1.3 Image Acquisition .....	4
1.4 Charge Transport .....	4
1.5 Output Structure .....	4
1.6 Dark Reference Pixels .....	4
1.7 Dummy Pixels .....	4
2.1 Package Drawing .....	5
2.2 Pin Description .....	6
3.1 Absolute Maximum Ratings .....	7
3.2 DC Operating Conditions .....	8
3.3 AC Operating Conditions .....	9
3.4 AC Timing Conditions .....	9
4.1 Performance Specifications .....	11
4.2 Typical Performance Characteristics .....	12
4.3 Defect Classification .....	13
5.1 Quality Assurance and Reliability .....	14
5.2 Ordering Information .....	14

## APPENDIX

Part Number Availability .....	15
--------------------------------	----

## FIGURES

Figure 1 Functional Block Diagram .....	3
Figure 2 Packaging Diagram .....	5
Figure 3 Packaging Pin Designations .....	6
Figure 4 Recommended Output Structure Load Diagram .....	8
Figure 5 Timing Diagrams .....	10



Eastman Kodak Company - Microelectronics Technology Division - Rochester, NY 14650-2010

Phone (716) 722-4385

Fax (716) 477-4947

## 1.1 Features

- 1.6M Pixel Area CCD
- 1536H x 1024V (9 mm) Pixels
- 13.8 mm H x 9.2 mm V Photosensitive Area
- 2-Phase Register Clocking
- Enhanced Responsivity
- 100% Fill Factor
- High Output Sensitivity (10mV/e-)
- Low Dark Current (<10pA/cm<sup>2</sup> @ 25°C)

## 1.2 Description

The KAF-1600 is a high performance monochrome area CCD (charge-coupled device) image sensor with 1536H x 1024V photoactive pixels designed for a wide range of image sensing applications in the 0.4 nm to 1.0 nm wavelength band. Typical applications include military, scientific, and industrial imaging. A 74 dB dynamic range is possible when operating at room temperature.

This technology simplifies the support circuits that drive the sensor and reduces the dark current without compromising charge capacity. Total chip size is 13.8mm x 9.2mm and is housed in a 24-pin, 0.805" wide DIL ceramic package with 0.1" pin spacing.

The sensor consists of 1552 parallel (vertical) CCD shift registers each 1032 elements long. These registers act as both the photosensitive elements and as the transport circuits that allow the image to be sequentially read out of the sensor. The elements of these registers are arranged into a 1536 x 1024 photosensitive array surrounded by a light shielded dark reference of 16 columns and 8 rows. Parallel (vertical) CCD registers transfer the image one line at a time into a single 1564 element (horizontal) CCD shift register. The horizontal register transfers the charge to a single output amplifier. The output amplifier is a two-stage source follower that converts the photo generated charge to a voltage for each pixel.

The sensor is built with a true two-phase CCD

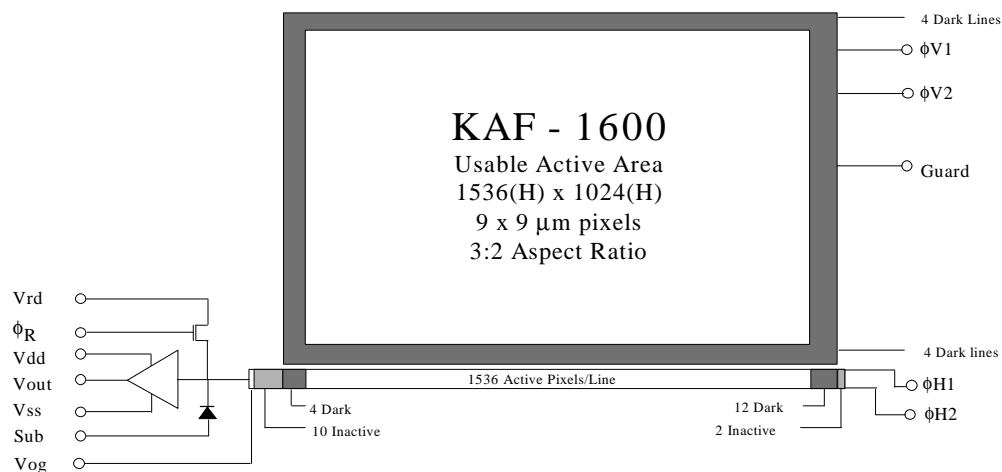

Figure 1 - Functional Block Diagram



Eastman Kodak Company - Microelectronics Technology Division - Rochester, NY 14650-2010

Phone (716) 722-4385

Fax (716) 477-4947

### 1.3 Image Acquisition

An electronic representation of an image is formed when incident photons falling on the sensor plane create electron-hole pairs within the sensor. These photon induced electrons are collected locally by the formation of potential wells at each photogate or pixel site. The number of electrons collected is linearly dependent on light level and exposure time and non-linearly dependent on wavelength. When the pixel's capacity is reached, excess electrons will leak into the adjacent pixels within the same column. This is termed blooming. During the integration period, the  $\phi V1$  and  $\phi V2$  register clocks are held at a constant (low) level.

See Figure 5 - Timing Diagrams.

### 1.4 Charge Transport

Referring again to Fig. 5 - Timing Diagrams, the integrated charge from each photogate is transported to the output using a two step process. Each line (row) of charge is first transported from the vertical CCD's to the horizontal CCD register using the  $\phi V1$  and  $\phi V2$  register clocks. The horizontal CCD is presented a new line on the falling edge of  $\phi V2$  while  $\phi H1$  is held high. The horizontal CCD's then transport each line, pixel by pixel, to the output structure by alternately clocking the  $\phi H1$  and  $\phi H2$  pins in a complementary fashion. On each falling edge of  $\phi H1$  a new charge packet is transferred onto a floating diffusion and sensed by the output amplifier.

### 1.5 Output Structure

Charge presented to the floating diffusion (FD) is

converted into a voltage and current amplified in order to drive off-chip loads. The resulting voltage change seen at the output is linearly related to the amount of charge placed on FD. Once the signal has been sampled by the system electronics, the reset gate ( $\phi_R$ ) is clocked to remove the signal and FD is reset to the potential applied by VRD. More signal at the floating diffusion reduces the voltage seen at the output pin. In order to activate the output structure, an off-chip load must be added to the Vout pin of the device - see Figure 4.

### 1.6 Dark Reference Pixels

Surrounding the peripheral of the device is a border of light shielded pixels. This includes 4 leading and 12 trailing pixels on every line excluding dummy pixels. There are also 4 full dark lines at the start of every frame and 4 full dark lines at the end of each frame. Under normal circumstances, these pixels do not respond to light. However, dark reference pixels in close proximity to an active pixel, or the outer bounds of the chip (including the first two lines out), can scavenge signal depending on light intensity and wavelength and therefore will not represent the true dark signal.

### 1.7 Dummy Pixels

Within the horizontal shift register are 10 leading and 2 trailing additional shift phases which are not associated with a column of pixels within the vertical register. These pixels contain only horizontal shift register dark current signal and do not respond to light. A few leading dummy pixels may scavenge false signal depending on operating conditions.



Eastman Kodak Company - Microelectronics Technology Division - Rochester, NY 14650-2010

Phone (716) 722-4385

Fax (716) 477-4947

## 2.1 Package Drawing

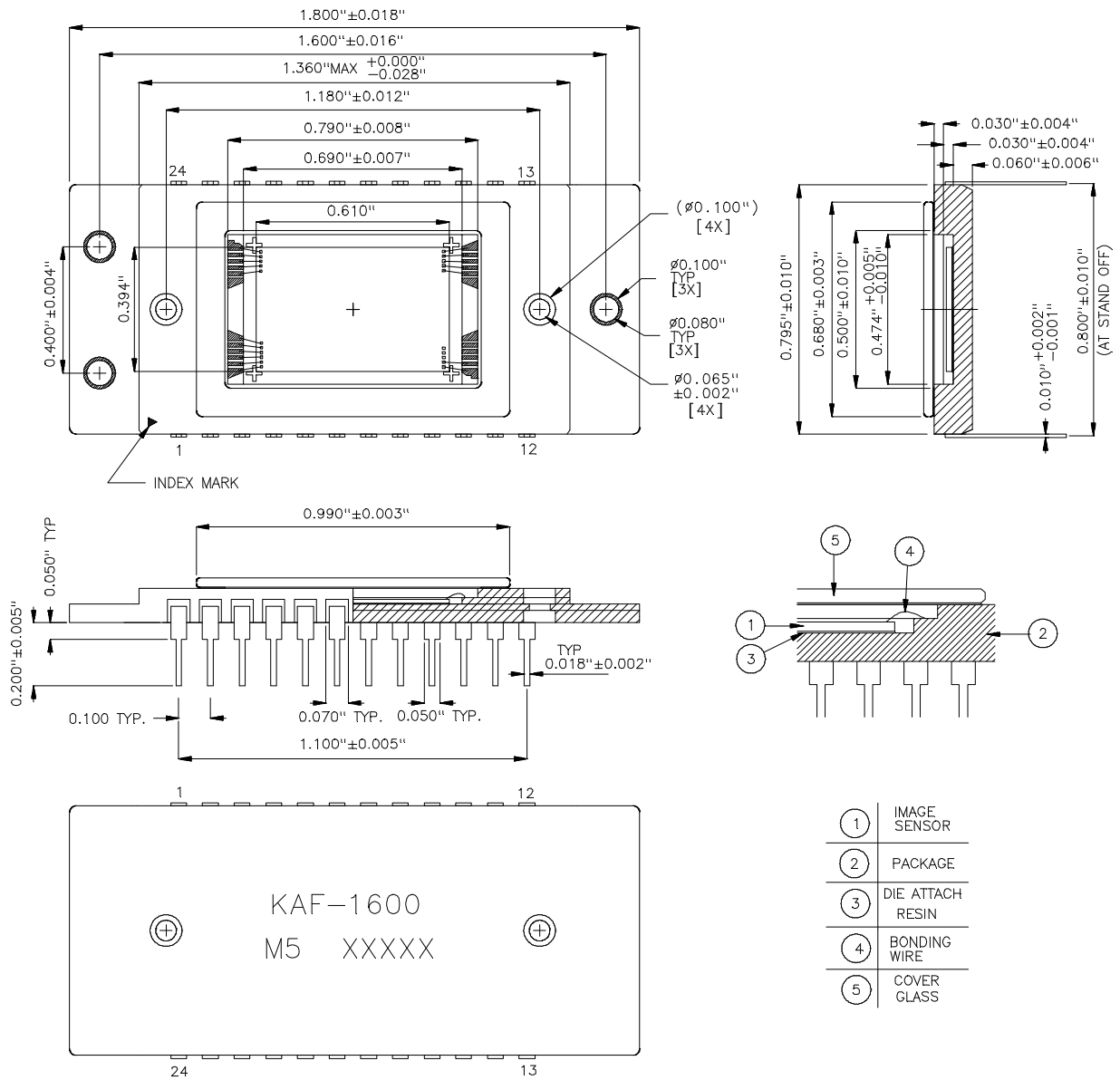

Detailed drawings available upon request.

Figure 2 - Package Drawing



Eastman Kodak Company - Microelectronics Technology Division - Rochester, NY 14650-2010

Phone (716) 722-4385

Fax (716) 477-4947

## 2.2 Pin Description

Pin	Symbol	Description	Pin	Symbol	Description
1	VOG	Output Gate	11, 12	N/C	No connection (open pin)
2	VOUT	Video Output	13	N/C	No connection (open pin)
3	VDD	Amplifier Supply	14	VSUB	Substrate (Ground)
4	VRD	Reset Drain	15, 16	$\phi_{V1}$	Vertical CCD Clock - Phase 1
5	$\phi_R$	Reset Clock	17, 18	$\phi_{V2}$	Vertical CCD Clock - Phase 2
6	VSS	Amplifier Supply Return	19, 20	$\phi_{V2}$	Vertical CCD Clock - Phase 2
7	$\phi_{H1}$	Horizontal CCD Clock - Phase 1	21, 22	$\phi_{V1}$	Vertical CCD Clock - Phase 1
8	$\phi_{H2}$	Horizontal CCD Clock - Phase 2	23	Guard	Guard Ring
9, 10	N/C	No connection (open pin)	24	N/C	No Connection (open pin)

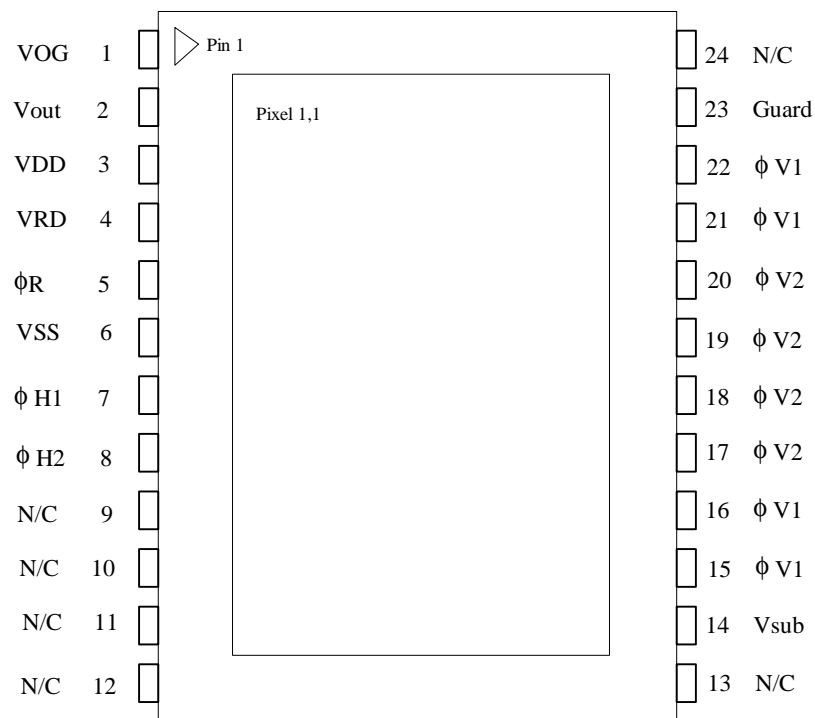

Figure 3 - Packaging Pin Designations



Eastman Kodak Company - Microelectronics Technology Division - Rochester, NY 14650-2010

Phone (716) 722-4385

Fax (716) 477-4947

## 3.1 Absolute Maximum Ratings

Description	Symbol	Min.	Max.	Units	Notes
Diode Pin Voltages	Vdiode	0	20	V	1,2
Gate Pin Voltages - Type 1	Vgate1	-16	16	V	1,3
Gate Pin Voltages - Type 2	Vgate2	0	16	V	1,4
Inter-Gate Voltages	Vg-g		16	V	5
Output Bias Current	Iout		-10	mA	6
Output Load Capacitance	Cload		15	pF	6
Storage Temperature	T		100	°C	
Humidity	RH	5	90	%	7

### Notes:

1. Referenced to pin VSUB.
2. Includes pins: VRD, VDD, VSS, VOUT.
3. Includes pins:  $\phi V1$ ,  $\phi V2$ ,  $\phi H1$ ,  $\phi H2$ .
4. Includes pins:  $\phi R$ , VOG.
5. Voltage difference between overlapping gates. Includes:  $\phi V1$  to  $\phi V2$ ,  $\phi H1$  to  $\phi H2$ ,  $\phi V2$  to  $\phi H1$ ,  $\phi H2$  to VOG.
6. Avoid shorting output pins to ground or any low impedance source during operation.
7. T=25°C. Excessive humidity will degrade MTTF.

**Caution:** This device contains limited protection against Electrostatic Discharge (ESD).  
Devices should be handled in accordance with strict ESD protective procedures for Class 1 devices.



Eastman Kodak Company - Microelectronics Technology Division - Rochester, NY 14650-2010

Phone (716) 722-4385

Fax (716) 477-4947

## 3.2 DC Operating Conditions

Description	Symbol	Min.	Nom.	Max.	Units	Max. DC Current (mA)	Notes
Reset Drain	VRD	10.5	11	11.5	V	0.01	
Output Amplifier Return	VSS	1.5	2.0	2.5	V	-0.5	
Output Amplifier Supply	VDD	14.5	15	15.5	V	I <sub>out</sub>	
Substrate	VSUB	0	0	0	V	0.01	
Output Gate	VOG	3.75	4	5	V	0.01	
Guard Ring	Guard	8.0	9.0	12.0	V	0.01	
Video Output Current	I <sub>out</sub>		-5	-10	mA	-	1

### Notes:

1. An output load sink must be applied to V<sub>out</sub> to activate output amplifier - see Figure below.

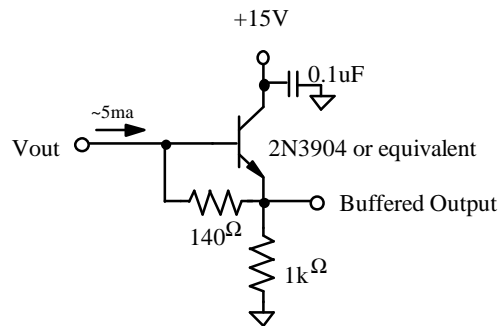

Figure 4 - Recommended Output Structure Load Diagram



Eastman Kodak Company - Microelectronics Technology Division - Rochester, NY 14650-2010

Phone (716) 722-4385

Fax (716) 477-4947

### 3.3 AC Operating Conditions

Description	Symbol	Level	Min.	Nom.	Max.	Units	Effective Capacitance	Notes
Vertical CCD Clock - Phase 1	$\phi V1$	Low	-8.5	-8.0	-7.5	V	24nF (all $fV1$ pins)	
		High	0	0.5	1.0	V		
Vertical CCD Clock - Phase 2	$\phi V2$	Low	-8.5	-8.0	-7.5	V	24nF (all $fV2$ pins)	
		High	0	0.5	1.0	V		
Horizontal CCD Clock - Phase 1	$\phi H1$	Low	-5.0	-4.0	-3.5	V	100pF	
		High	5.0	6.0	6.5	V		
Horizontal CCD Clock - Phase 2	$\phi H2$	Low	-5.0	-4.0	-3.5	V	100pF	
		High	5.0	6.0	6.5	V		
Reset Clock	$\phi R$	Low	-3.0	-4.0	-1.75	V	5pF	
		High	3.5	2.0	5.0	V		

**Notes:**

1. All pins draw less than 10uA DC current.
2. Capacitance values relative to VSUB.

### 3.4 AC Timing Conditions

Description	Symbol	Min.	Nom.	Max.	Units	Notes
$\phi H1, \phi H2$ Clock Frequency	$f_H$		10	15	MHz	1, 2, 3
$\phi V1, \phi V2$ Clock Frequency	$f_V$		100	125	kHz	1, 2, 3
Pixel Period (1 Count)	$t_e$	67	100		ns	
$\phi H1, \phi H2$ Setup Time	$t_{fHS}$	0.5	1		$\mu s$	
$\phi V1, \phi V2$ Clock Pulse Width	$t_{fV}$	4	5		$\mu s$	2
Reset Clock Pulse Width	$t_{fR}$	10	20		ns	4
Readout Time	$t_{readout}$	121	178		ms	5
Integration Time	$t_{int}$					6
Line Time	$t_{line}$	117.4	172.5		$\mu s$	7

**Notes:**

1. 50% duty cycle values.
2. CTE may degrade above the nominal frequency.
3. Rise and fall times (10/90% levels) should be limited to 5-10% of clock period. Cross-over of register clocks should be between 40-60% of amplitude.
4.  $f_R$  should be clocked continuously.
5.  $t_{readout} = (1032 * t_{line})$
6. Integration time is user specified. Longer integration times will degrade noise performance.
7.  $t_{line} = (3 * t_{\phi V}) + t_{\phi HS} + (1564 * t_e) + t_e$



Eastman Kodak Company - Microelectronics Technology Division - Rochester, NY 14650-2010

Phone (716) 722-4385

Fax (716) 477-4947

## Frame Timing

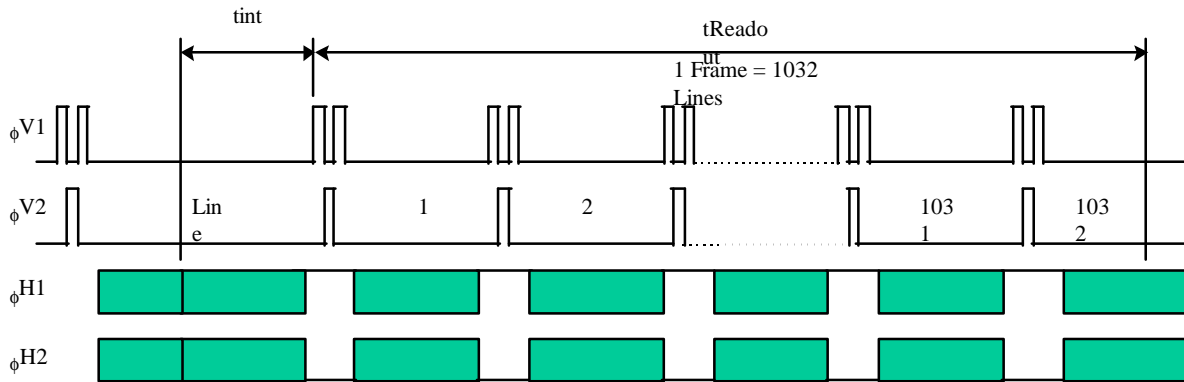

### Line Timing Detail

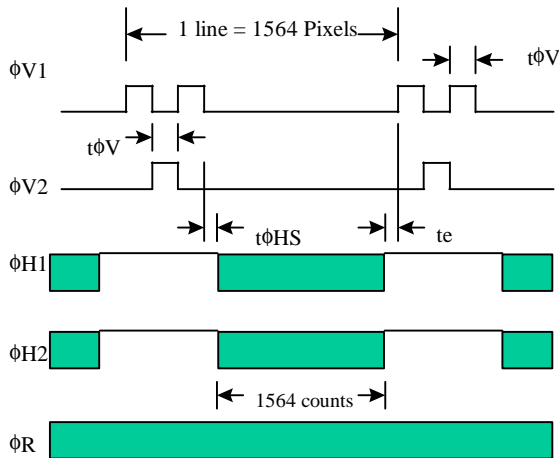

### Pixel Timing Detail



### Line Content

1-10 11-14 15 - 1550 1551-1562 1563-1564

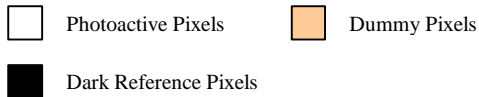

$V_{sat}$  Saturated pixel video output signal  
 $V_{dark}$  Video output signal in no light situation, not zero due to  
 $V_{pix}$  Pixel video output signal level, more electrons = more  
 $V_{doc}$  Video level offset with respect to  $v_{sub}$   
 $V_{sub}$  Analog Ground

\* See Image Acquisition - section 1.3 (page 4)

Figure 5 - Timing Diagrams



Eastman Kodak Company - Microelectronics Technology Division - Rochester, NY 14650-2010

Phone (716) 722-4385

Fax (716) 477-4947

## 4.1 Performance Specifications

All values measured at 25°C, and nominal operating conditions. These parameters exclude defective pixels.

Description	Symbol	Min.	Nom.	Max.	Units	Notes
Saturation Signal						
Vertical CCD capacity	Nsat	85000	100000	120000	electrons / pixel	1
Horizontal CCD capacity		170000	200000	240000		
Output Node capacity		190000	220000	240000		
Red Quantum Efficiency ( $\lambda=650\text{nm}$ )	Rr		35		%	
Green Quantum Efficiency ( $\lambda=550\text{nm}$ )	Rg		35		%	
Blue Quantum Efficiency ( $\lambda=450\text{nm}$ )	Rb		12		%	
Photoresponse Non-Linearity	PRNL		1	2	%	2
Photoresponse Non-Uniformity	PRNU		1	3	%	3
Dark Signal	Jdark		15	50	electrons / pixel / sec pA/cm <sup>2</sup>	4
			3	10		
Dark Signal Doubling Temperature		5	6	7	°C	
Dark Signal Non-Uniformity	DSNU		15	50	electrons / pixel / sec	5
Dynamic Range	DR	72	74		dB	6
Charge Transfer Efficiency	CTE	0.99995	0.99998			
Output Amplifier DC Offset	V <sub>dc</sub>	9.5	10.5	11.5	V	7
Output Amplifier Bandwidth	f <sub>-3dB</sub>		45		Mhz	8
Output Amplifier Sensitivity	V <sub>out</sub> /N <sub>e~</sub>	9	10	11	uV/e~	
Output Amplifier output Impedance	Z <sub>out</sub>	175	200	250	Ohms	
Noise Floor	n <sub>e~</sub>		15	20	electrons	9

### Notes:

- For pixel binning applications, electron capacity up to 330000 can be achieved with modified CCD inputs. Each sensor may have to be optimized individually for these applications. Some performance parameters may be compromised to achieve the largest signals.
- Worst case deviation from straight line fit, between 1% and 90% of V<sub>sat</sub>.
- One Sigma deviation of a 128x128 sample when CCD illuminated uniformly.
- Average of all pixels with no illumination at 25 °C..
- Average dark signal of any of 12 x 8 blocks within the sensor. (each block is 128 x 128 pixels)
- 20log ( N<sub>sat</sub> / n<sub>e~</sub>) at nominal operating frequency and 25 °C.
- Video level offset with respect to ground
- Last output amplifier stage only. Assumes 10pF off-chip load..
- Output noise at 25 °C , nominal operating frequency, and tint = 0.



Eastman Kodak Company - Microelectronics Technology Division - Rochester, NY 14650-2010

Phone (716) 722-4385

Fax (716) 477-4947

## 4.2 Typical Performance Characteristics

### KAF-1600 Spectral Response

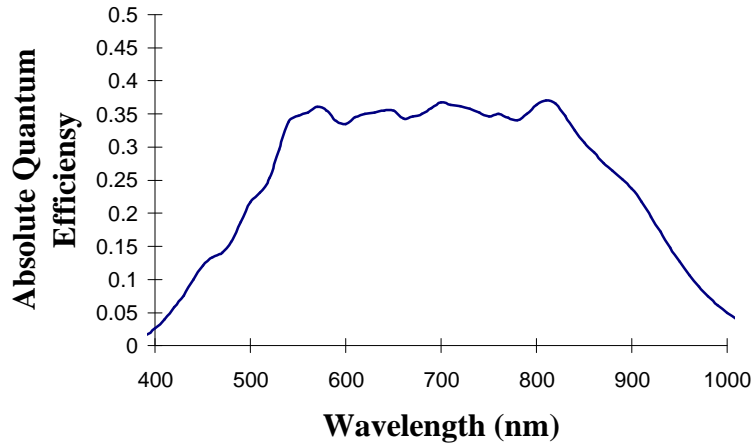

### KAF-1600 Linearity 1 MHz readout -20 C

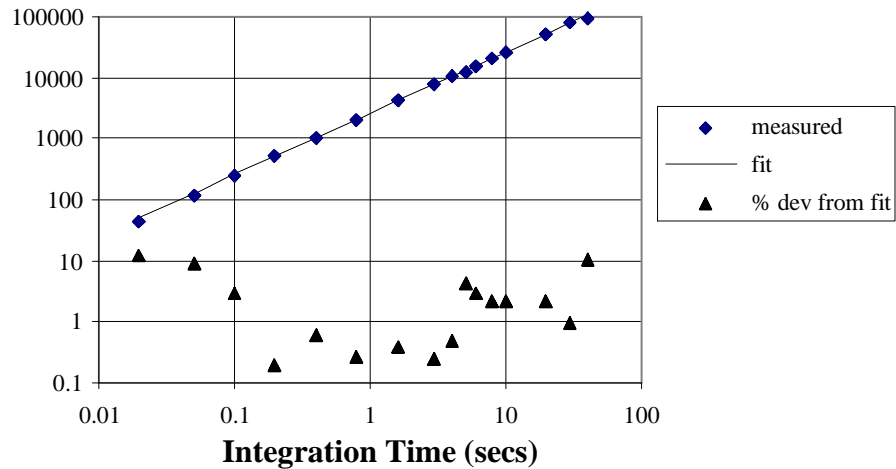

Eastman Kodak Company - Microelectronics Technology Division - Rochester, NY 14650-2010

Phone (716) 722-4385

Fax (716) 477-4947

## 4.3 Defect Classification

Defect tests performed at T=25°C.

Class	Point Defects		Cluster Defects		Column Defects	
	Total	Zone A	Total	Zone A	Total	Zone A
C0	0	0	0	0	0	0
C1	≤5	≤2	0	0	0	0
C2	≤10	≤5	≤4	≤2	≤2	0
C3	≤20	≤10	≤8	≤4	≤4	≤2

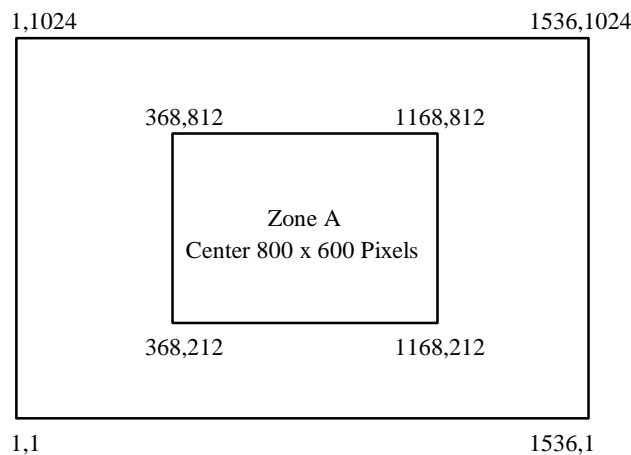

Point Defect	DARK: A pixel which deviates by more than 6% from neighboring pixels when illuminated to 70% of saturation, OR BRIGHT: A Pixel with dark current > 5000 e/pixel/sec at 25C.
Cluster Defect	A grouping of not more than 5 adjacent point defects
Column Defect	A grouping of >5 contiguous point defects along a single column, OR A column containing a pixel with dark current > 12,000e/pixel/sec, OR A column that does not meet the minimum vertical CCD charge capacity, OR A column which loses more than 250 e under 2Ke illumination.
Neighboring pixels	The surrounding 128 x 128 pixels or ±64 columns/rows.
Defect Separation	Column and cluster defects are separated by no less than two (2) pixels in any direction (excluding single pixel defects).
Defect Region Exclusion	Defect region excludes the outer two (2) rows and columns at each side/end of the sensor.



Eastman Kodak Company - Microelectronics Technology Division - Rochester, NY 14650-2010

Phone (716) 722-4385

Fax (716) 477-4947

## 5.1 Quality Assurance and Reliability

- 5.1.1 Quality Strategy: All devices will conform to the specifications stated in this document. This is accomplished through a combination of statistical process control and inspection at key points of the production process.
- 5.1.2 Replacement: All devices are warranted against failure in accordance with the terms of Terms of Sale.
- 5.1.3 Cleanliness: Devices are shipped free of contamination, scratches, etc. that would cause a visible defect.
- 5.1.4 ESD Precautions: Devices are shipped in a static-safe container and should only be handled at static-safe work stations.
- 5.1.5 Reliability: Information concerning the quality assurance and reliability testing procedures and results are available from the Microelectronics Technology Division and can be supplied upon request.
- 5.1.6 Test Data Retention: Devices have an identifying number of traceable to a test data file. Test data is kept for a period of 2 years after date of shipment.

## 5.2 Ordering Information

See Appendix 1 for available part numbers

Address all inquiries and purchase orders to:

Microelectronics Technology Division  
Eastman Kodak Company  
Rochester, New York 14650-2010  
Phone: (716) 722-4385  
Fax: (716) 477-4947

Kodak reserves the right to change any information contained herein without notice. All information furnished by Kodak is believed to be accurate.

### **WARNING: LIFE SUPPORT APPLICATIONS POLICY**

Kodak image sensors are not authorized for and should not be used within Life Support Systems without the specific written consent of the Eastman Kodak Company.

Product warranty is limited to replacement of defective components and does not cover injury, or property or other consequential damages.



Eastman Kodak Company - Microelectronics Technology Division - Rochester, NY 14650-2010

Phone (716) 722-4385

Fax (716) 477-4947

## Appendix

### Part Number Availability

Note: This appendix may be updated independently of the performance specification.  
Contact Eastman Kodak for the latest revision.

Device Name	Available Part Numbers	Features
KAF-1600	5B7033	Clear Taped Cover Glass, Class 0
KAF-1600	5B7400	Clear Taped Cover Glass, Class 1
KAF-1600	5B7401	Clear Taped Cover Glass, Class 2
KAF-1600	5B7402	Clear Taped Cover Glass, Class 3
KAF-1600	5B7403	Clear Taped Cover Glass, Engineering Grade
KAF-1600	5B7404	Clear Taped Cover Glass, Mechanical Grade
KAF-1600	5B7032	Clear Sealed Cover Glass, Class 0
KAF-1600	5B7211	Clear Sealed Cover Glass, Class 1
KAF-1600	5B7212	Clear Sealed Cover Glass, Class 2
KAF-1600	5B7213	Clear Sealed Cover Glass, Class 3
KAF-1600	5B7325	Clear Sealed Cover Glass, Engineering Grade
KAF-1600	5B7373	Clear Sealed Cover Glass, Mechanical Grade

Note: These devices are also available with UV phosphor coating and quartz cover glass.  
Contact Microelectronics Technology Division for details.



Eastman Kodak Company - Microelectronics Technology Division - Rochester, NY 14650-2010

Phone (716) 722-4385

Fax (716) 477-4947